

Dangler Installation Instruction

CUBE SHAPE DANGLER
SKU:SGDGCB-150X150-R

EZEXPO
sa.ezexpo.com



Formulate Straight Fabric Display

Attaching Graphics

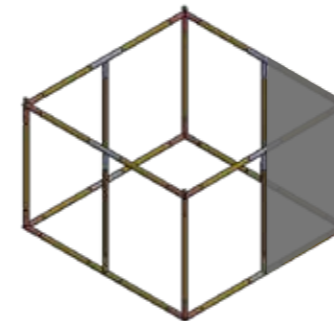

①

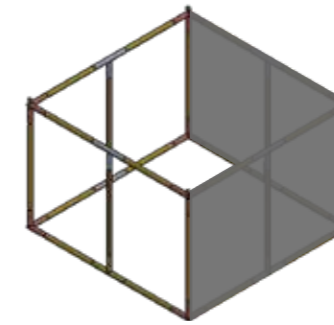

②

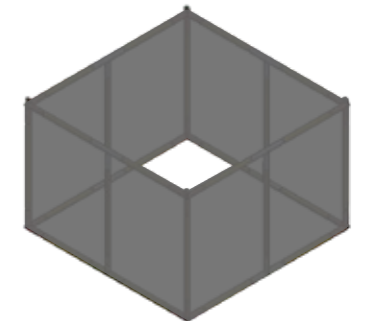

③

Cube Shape Dangler | SKU:SGDGCB-150X150-R

2



Dangler Installation Instruction

SKU:SGDGCB-150X150-R



STEPS 1

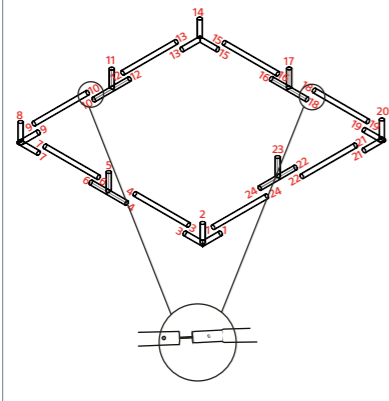

STEPS 2

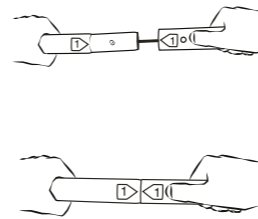
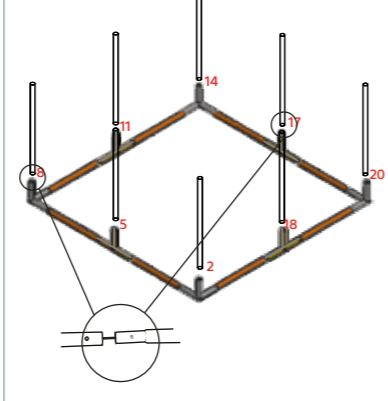

PARTS

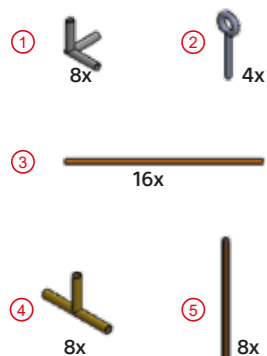

STEPS 3

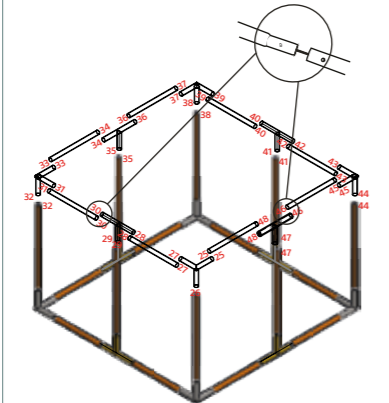

ASSEMBLY

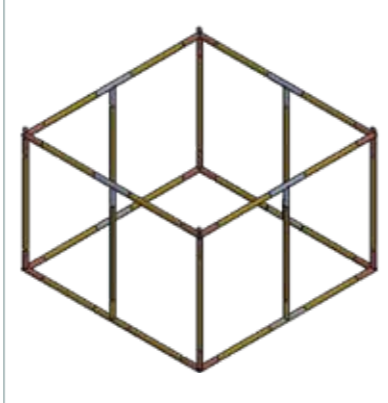

Graphics & printing Installation



Perspective

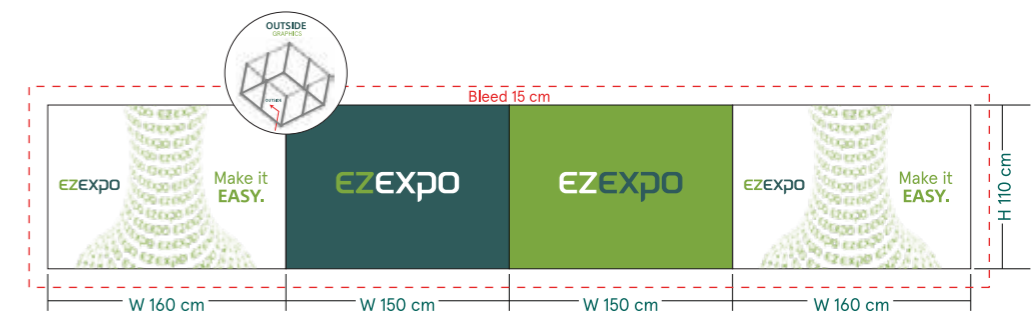

Out Side Graphics

Notes :

- Please Use CMYK Mode For best Color Matching Check all scans are CMYK (not RGB)
- 70 - 100 dpi at the overall graphic layout size.
- Be aware of Safe Visible Area and keep important images and text inside this line.
- Convert all text to outlines before saving finished artwork file
- File Formats must be in: Photoshop (.psd) Illustrator (.ai) - Acrobat (.pdf) - Other (.tif, .eps)
- Counter:
 - The graphic wrap is attached to the frame with a combination of the special one piece panel strip and magnetic tape.



Inside Graphics

Cube Shape Dangler | SKU:SGDGCB-150X150-R

3



1

CUBE SHAPE DANGLER

SKU:SGDGCB-150X150-R

